



**Safety, hygiene, efficiency and measurable sustainability.**

GEA Tiromat Packaging

## More than 50 years of expertise

With a workforce of around 25,000 the MDax-quoted GEA Group is one of the world's leading suppliers in the field of special mechanical engineering. The GEA Group has worldwide operations in six divisions. With our competencies we are one of the industry's market and technology leaders.

GEA Tiromat Packaging is a leading manufacturer of machines for packaging sterile single-use medical articles and for the secondary packaging of infusion bags, as well as flasks and vials in the pharmaceutical industry.



## System solutions for every assignment



### Wide service portfolio

For customers who operate worldwide and those who work on a local basis we plan and implement performance-oriented solutions, from single machines through to integration in complete packaging lines. GEA Tiromat Packaging not only supplies packaging machines but also all kinds of inline printing systems and downstream equipment for package converging and quality control. From cannulas or wound dressings, surgical sets, baby supplies and single-use syringes through to secondary packaging for infusion bags: we have the right solution for every job.

### Need-oriented flexibility is one of our strengths

GEA PowerPak thermoformers form the heart of our packaging solutions. They guarantee maximum effectiveness, long service life and maximum product safety. From production development and cost reduction through to enhanced production performance – all relevant factors for process optimisation and hygiene have been considered. The wide choice of modules means that individual functional adaptation and extension are possible.

## GEA PowerPak – Technology of the latest generation

GEA PowerPak is a thoroughly tried and tested series of deep-drawing machines with innovative technology which cover all customer-specific requirements in the medical and pharmaceutical industry. The smallest thermoformer in this family has a total length of only 3.8 metres and thus a minimal space requirement; three larger models complete the portfolio.

Except the PowerPak<sup>ST</sup> all machines are of flexible design, can be extended as required by adding modules and can be adjusted for any desired application. Innovative technology, state-of-the-art control systems, high-quality materials, flexibly adjustable cutting systems and a hygienic design mean that the GEA PowerPak is an economic and reliable alternative for all to whom performance is important.



GEA PowerPak<sup>ST</sup>: Packed Performance



GEA PowerPak<sup>XT</sup>: Functional Performance



GEA PowerPak<sup>RT</sup>: Versatile Performance



GEA PowerPak<sup>NT</sup>: Peak Performance

## One series – many benefits

### Performance at a glance

- **Long lifespan:** sturdy, strong frame.
- **Optimum product safety:** special, low-maintenance membrane sealing system for even and high sealing pressure, secure sealing and reliable peel. Optional lifting upper tool parts to prevent radiant heat\*.
- **High machine availability:** Continuous performance monitoring allows you to make better use of the machine's potential. Efficiency monitoring on OEE principles. Permanent monitoring and display of machine performance and reporting for fault analysis. Savings in costs thanks to fine tuning of the packaging process.
- **Complete control:** The relevant production data are displayed on the monitor or can be transferred to a superordinate control system.
- **Fast and simple maintenance, inspection and cleaning:** made of stainless steel with hinged side-sheets\*, open chain guides, separated function modules.
- **Two separate control cabinets, one each for electronics and pneumatics:** electronic cabinet can also be set up externally\*.
- **Fast diagnosis:** fault-testing program for complete machine including all function modules.
- **Ease of maintenance:** Optimised design with open frame and folding tool supports for rapid access to all components.
- Maintenance- and lubricant-free lifting in the forming and sealing station.
- High technical machine availability.
- **Replacement and wear parts:** Use of identical parts for all machine concepts helps to minimise spare parts inventory and ensure rapid worldwide availability of parts.
- **Short changeover times:** With various tool-change systems the downtimes of your production are reduced.

\*Depending on type

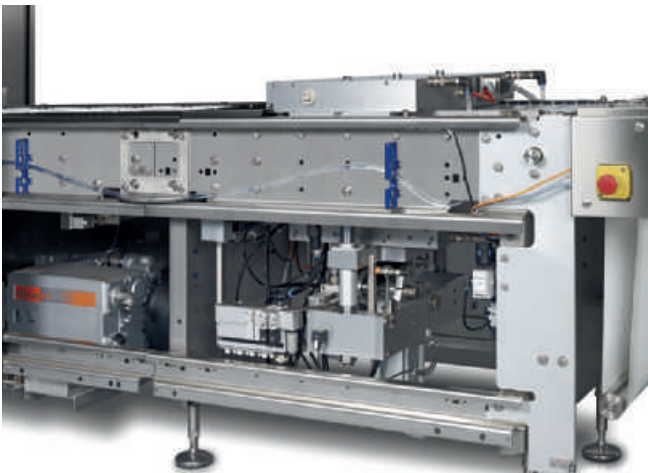

Forming station



Sealing station

## Print solutions to meet your needs

Not only hygiene, but also the correct marking is crucial to ensure that medical products are handled responsibly. The information given on packs is therefore subject to wide-ranging requirements: factors such as durability, water resistance, adhesion

and size define the technical solution of choice. No other manufacturer of packaging machines offers so many integrated print solutions for all conceivable applications.

GEA TiroPrint



Flexo printer

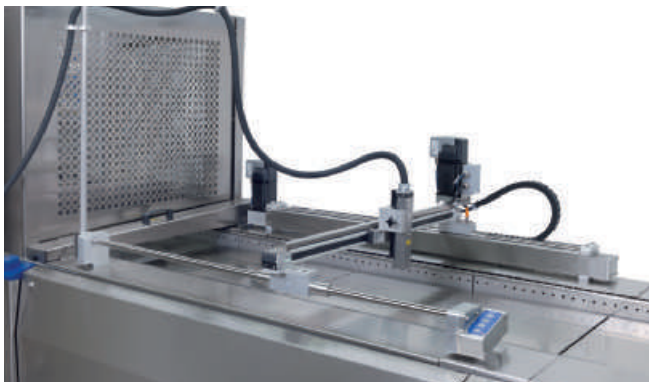

Inkjet printer



Thermotransfer printer



Examples of printed packs

### Labelling with GEA TiroLabel®

The labellers in the TiroLabel® family stand for precise positioning and perfect, potentially all-sided printing at up to 200 labels per minute. Backing paper widths of up to 200 mm provide a wide design scope. The GEA TiroLabel® is not only the world's first cross-web labeller with which label reels can also be changed during ongoing operation. It also has the distinguishing feature of a spring-loaded finger system which ensures that labels are applied without damage even on uneven surfaces.

### Marking with GEA TiroPrint®

GEA Tiromat Packaging offers the perfect solution for any printing job: from inkjet and thermotransfer to flexoprint on different media, such as paper or Tyvek®. Of course, all industrially used films can also be printed on. The many different character sets and graphics leave a lot of scope for free design.

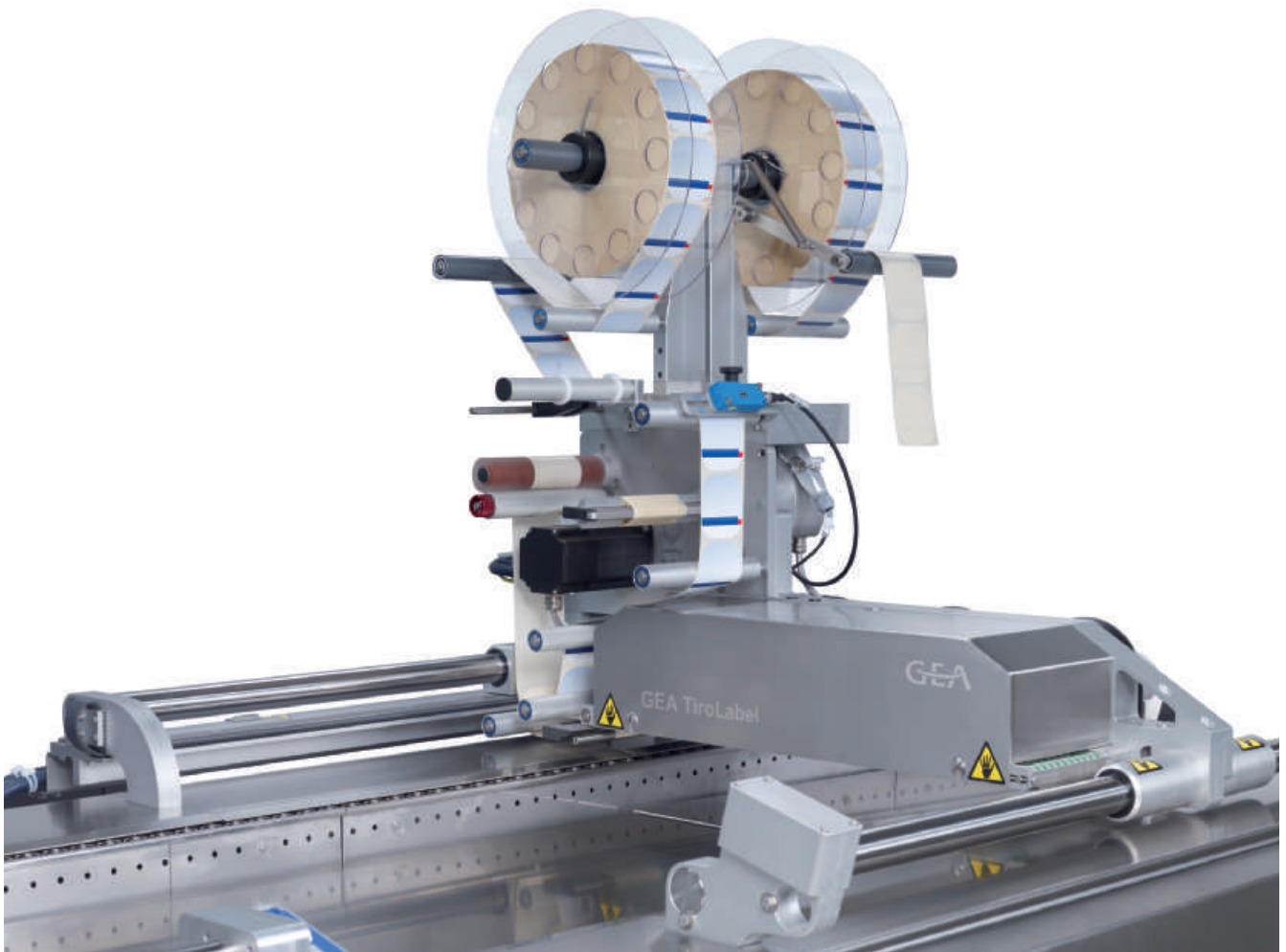

TiroLabel® cross web labeller



Top web labeller

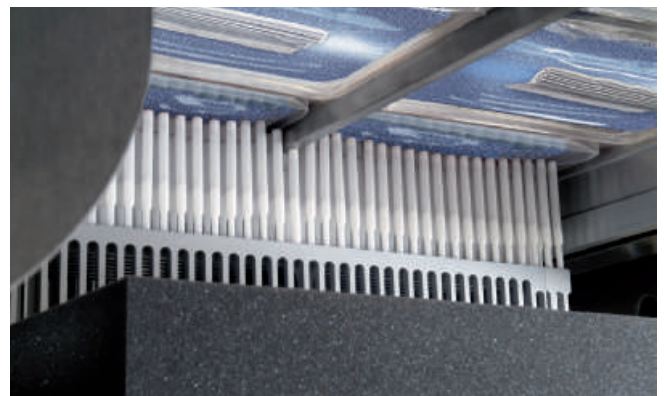

Bottom web labeller

# Complete cost control with production monitoring

Medical products must meet the highest standards when it comes to sterility. At the same time every company is interested in working as efficiently and cost-effectively as possible. That's why our thermoformers from the GEA PowerPak family are equipped with programs which guarantee cost certainty and optimum working processes.

## TrackMax®- Monitoring and managing production processes

TrackMax® is a software-based solution that continuously monitors the entire production process. This open, future-proof system can take account of new technologies just as easily as it can accommodate specific customer needs, the special features of a foreign market, or altered legal requirements.

## CostFox – Efficiency monitoring according to OEE

CostFox is a software, which gathers and evaluates, in detail, all production parameters. Here's how it works in practice: GEA provides you with a real-time operating console and the so-called runOmeter. The runOmeter displays the machine's production status compared against a preset target value (Key Performance Indicator). If this value is not reached, the operator can call up the background program CostFox on the operating

console in order to view all disruptions to the production process. CostFox provides the operator with all the needed information in detail at the right time. This allows the operator to easily identify any potential for optimisation and react efficiently with long-term effect to events that are critical in terms of performance. The benefits for you are increased profitability of your packaging equipment and achieving savings you could not have possibly imagined.

## UptiFox – Maintenance management, optimisation management, remote analysis

Increased safety and performance - that's what the web-based service tool UptiFox stands for. It will notify you via e-mail of all upcoming maintenance tasks and opens up a remote monitoring channel to the machine parameter database and will show the current improvement potential. Here, each exceeded threshold value is shown together with the necessary optimisation steps. Downtime is reduced by a tailored real-time prevention plan. Due to the location-independency of UptiFox, operation is extremely convenient. A Camera Headset simplifies mechanical fault diagnosis, and enables analysis within minutes and the ability to share information with several experts.

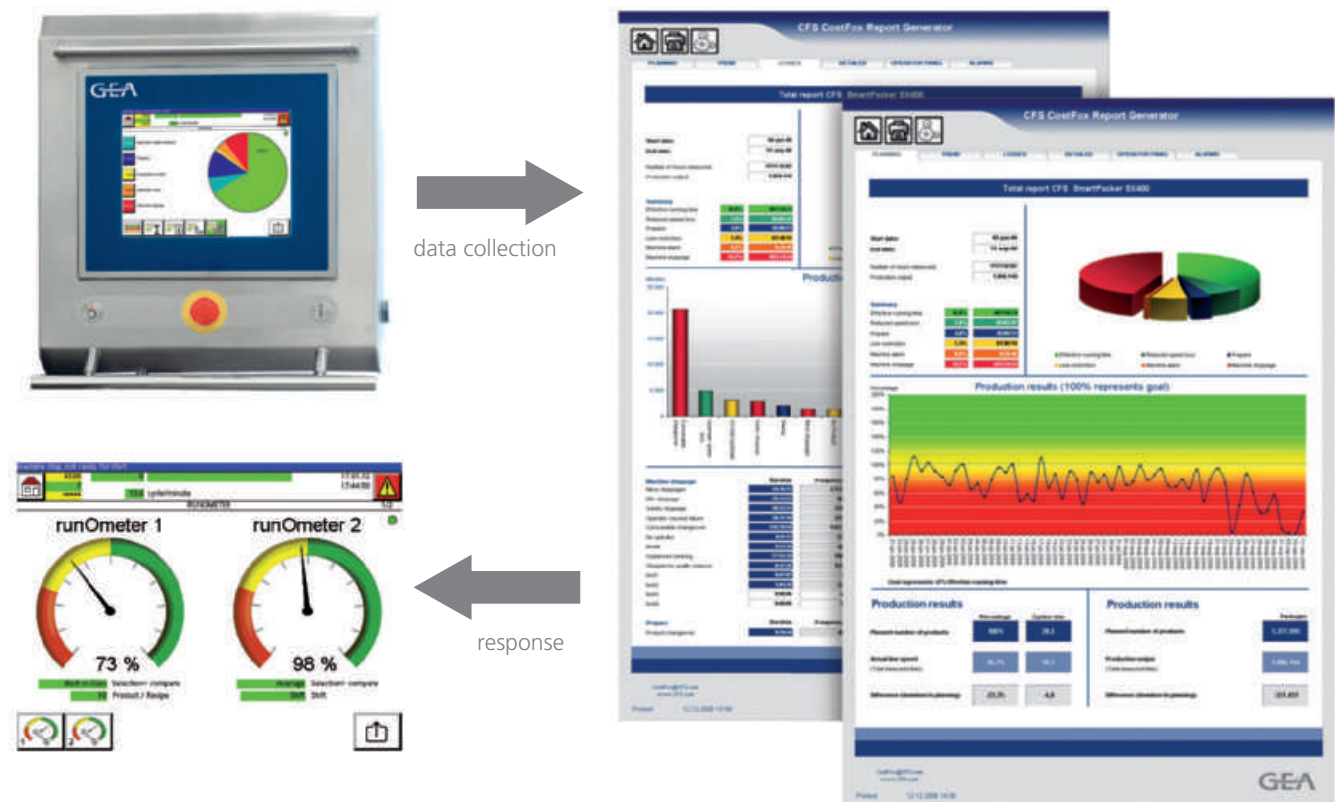



## Safety in all phases – Qualification and product testing

A careful qualification including documentation and effective product testing are the basis in packaging technology for functioning systems and constant quality. Only if you gear your processes to the optimum you can achieve the best results, avoid downtimes and produce economically.

### Documented and qualified

Validation processes are just as important as equipment and software in medical packaging. For packaging solutions from GEA Tiromat Packaging, qualification packages are available based on the guidelines of the FDA (Food and Drug Administration) and GAMP (Good Automated Manufacturing Practice). These support the development, implementation and docu-

mentation of a validation process that is precisely tailored to the respective product. The degree of detail can be individually adapted to your specific requirements.

### Check of pack and product quality

Modern camera and sensor systems help ensure greater safety and enhanced effectiveness, especially in medical packaging. They can, for example, check that packs have been properly filled. Furthermore packs with protruding products can be detected before they reach the sealing station. It is also possible to check the legibility of all kind of print jobs on the packs such as barcodes etc. There is the right system available for every kind of application.

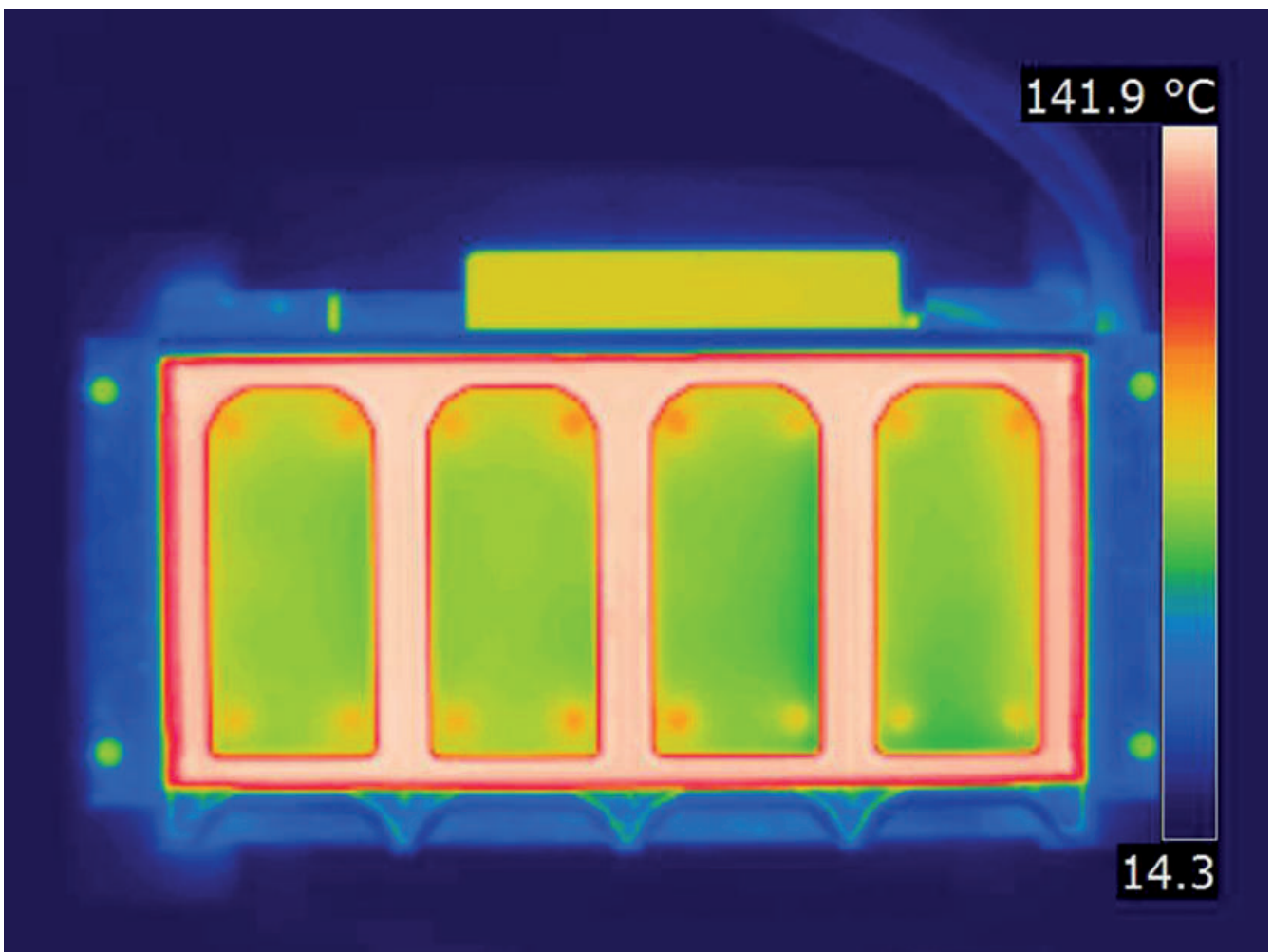

Thermal image

## Our Design Department is there to help and support you

Tailored to your needs and application, 3D pack and design drawings of the machine layout are provided already in the quotation phase to help you make a decision.

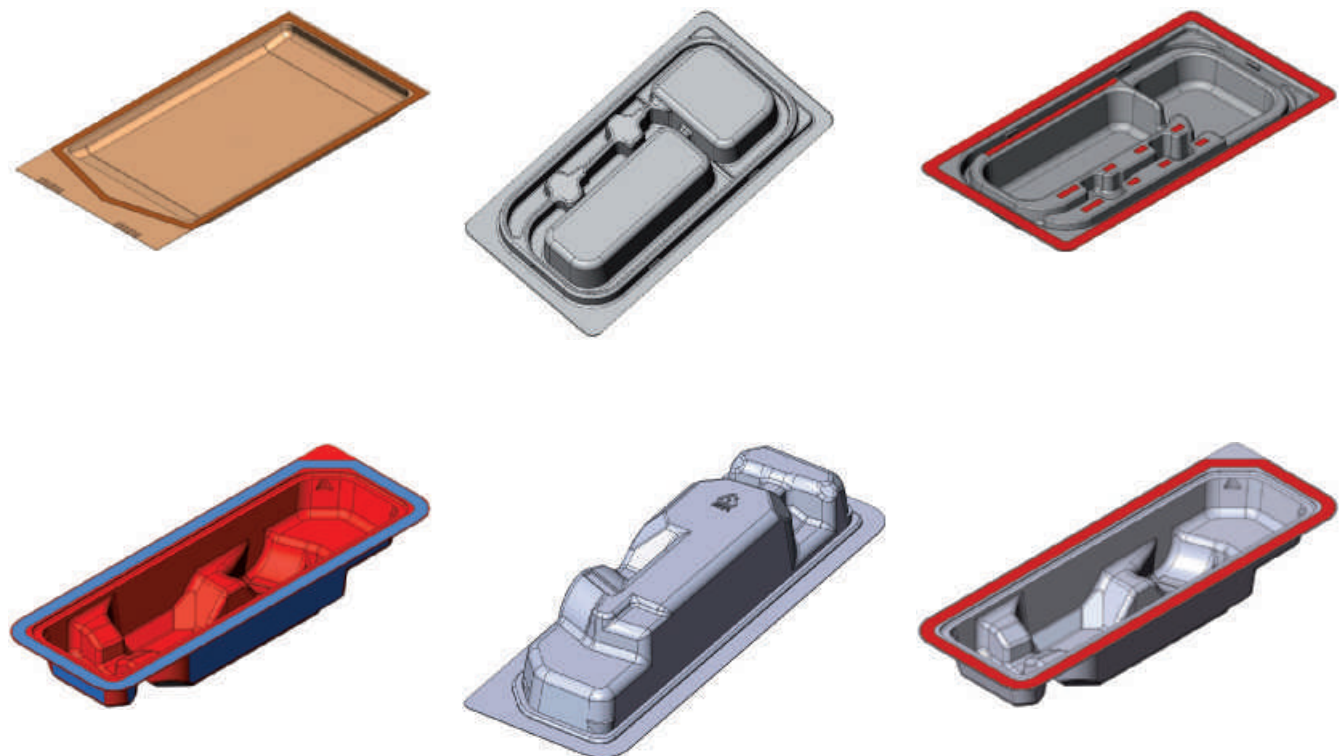
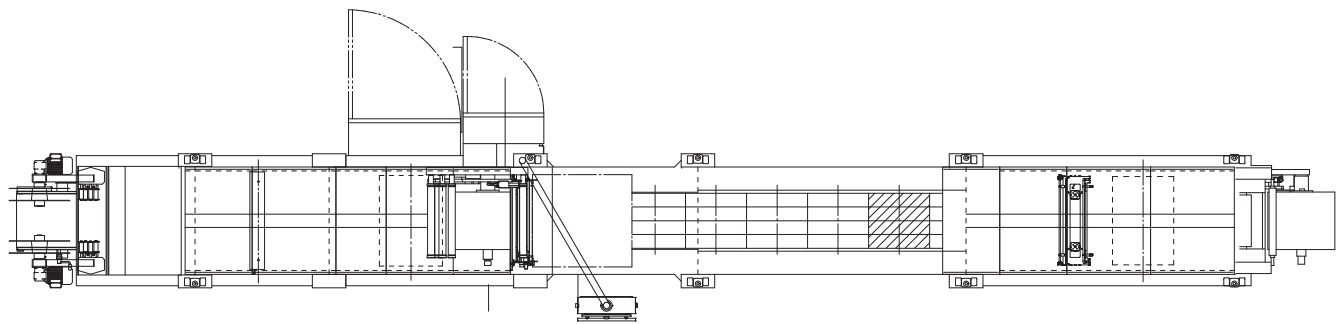
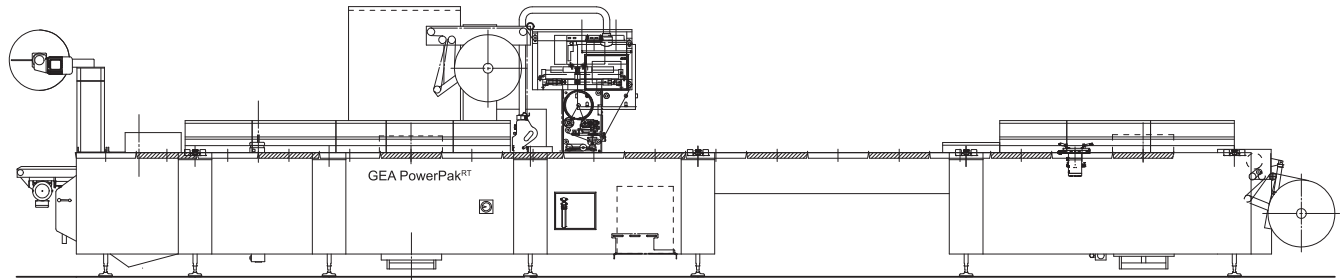

## Technology Centre

When it comes to packaging technology GEA Tiromat Packaging is the expert you can count on. For more than 50 years we have been trend-setting and constantly working to set new standards for productivity. We never stop employing all the latest technologies to optimise hygiene, efficiency, output, durability, future viability, flexibility and product safety through hygienic machine design.

Our guiding principle is to gear ourselves to the packaging needs and suggestions of our customers, with whom we cooperate closely to develop pioneering solutions. With constant innovations GEA Tiromat Packaging is steadily pushing out the boundaries of the possible.



Technology Centre in Wallau

In our Technology Centre in Wallau we offer you:

- Packaging consulting, package development and package design.
- Prototyping and production of sample packs.
- Packaging ideas with customer products.
- Application development and advice.
- Film tests.
- Performance tests and validation.
- Audits on optimisation of your processes.
- Practice-oriented training, interactive and hands-on.
- Technology and application seminars.



*We live our values.*

Excellence • Passion • Integrity • Responsibility • GEA-versity

GEA Group is a global mechanical engineering company with multi-billion euro sales and operations in more than 50 countries. Founded in 1881 the company is one of the largest providers of innovative equipment and process technology. GEA Group is listed in the STOXX Europe 600 Index.

## **GEA Tiromat Packaging**

**GEA Food Solutions Germany GmbH**

Im Rutttert, D-35216 Biedenkopf-Wallau, Germany  
Tel. +49 6461 801 0, Fax +49 6461 801 100  
[gea-foodsolutions.info@gea.com](mailto:gea-foodsolutions.info@gea.com), [www.gea.com](http://www.gea.com)